

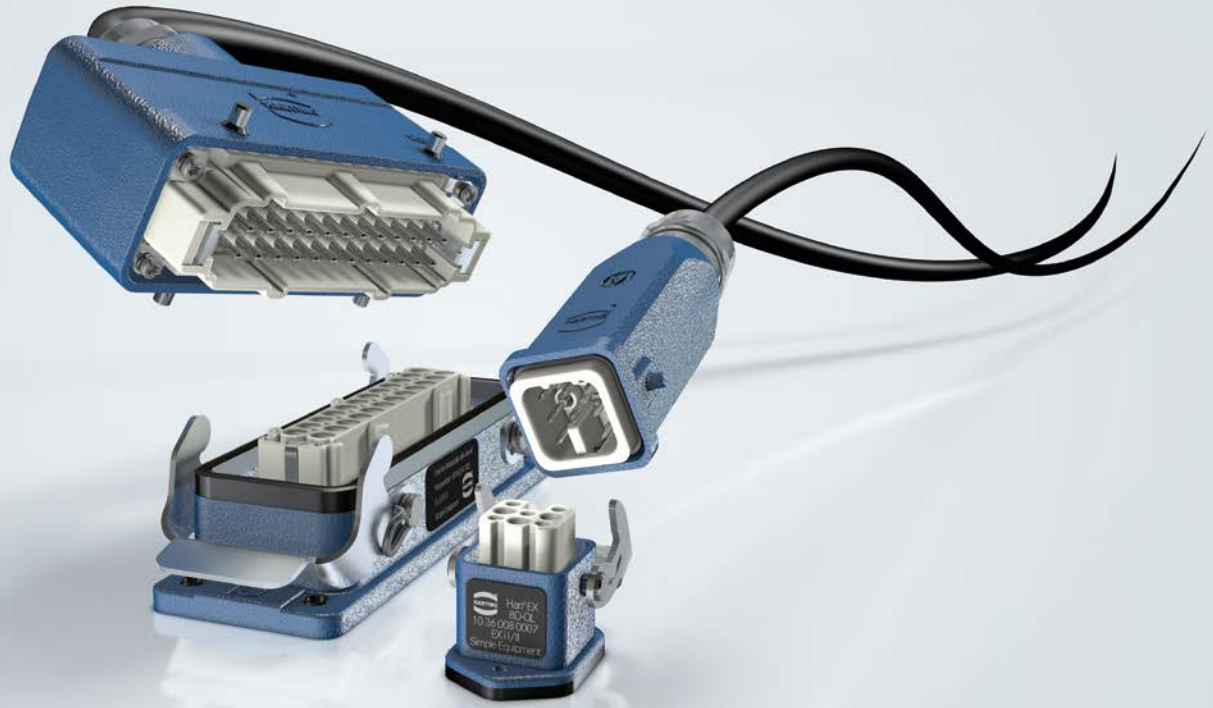

Pushing Performance



People | Power | Partnership

## HARTING Han-Ex<sup>®</sup>

Connectors for explosion-hazardous environments

---

# Content & General information

## Content

Content & General information .....	02	Maximum surface temperatures for equipment ....	11
Basics of explosion protection .....	03	Ignition protection types .....	12
Overview on international standards.....	04	Connecting Ex and Non-Ex areas .....	13
Zone classification in Europe .....	05	Han® Ex Sets – Hoods/Housings Size 3A .....	14
Gas explosion groups – European standards .....	07		
Hazardous area classification – North America ....	08		
Hazardous area classification – Europe .....	10		

### Field of application

HARTING Industrial Connectors are applicable in a wide variety of electronic and electrical applications. The degree of protection of all hoods and housings is in accordance with international standard IEC 60 529 / EN 60 529.

- Power Utilities
- Industrial Instrumentation
- Robotics
- Conveyor Equipment
- Chemical Plants
- Transportation
- Machine Tool Controls
- Injection Moulding
- ...and many more.



Certified according to EN ISO 9001 in design/development, production, installation and servicing

### Specifications:

VDE 0110

Table concerning clearance and creepage distances

VDE 0627

Connectors and plug devices

Standards:

DIN EN 175301-801, DIN EN 61 984

### Note:

Connectors should not be coupled and decoupled under electrical load. Connectors of the same or different series being mounted side by side may be protected against incorrect mating by the use of coding options.

### General information:

It is the user's responsibility to check whether the components illustrated in this catalogue comply with different regulations from those stated in special fields of application which we are unable to foresee. We reserve the right to modify designs in order to improve quality, keep pace with technological advancement or meet particular requirements in production.

### Imprint

© 2019, Editorial date 11/19, HARTING

Electric GmbH & Co. KG, Espelkamp, Germany

Author: HARTING

All rights reserved, including those of the translation.

No part of this manual may be reproduced in any form (print, photocopy, microfilm or any other process), processed, duplicated or distributed by means of electronic systems without the written permission of HARTING Electric GmbH & Co. KG, Espelkamp.

Subject to alterations without notice.

# Basics of explosion protection

## Causes of explosions

To set up an exothermic reaction like an explosion the following three components have to interact:

- Fuel: flammable vapors, liquids or gases or flammable dusts and fibres
- Oxidizer: generally air or oxygen
- Ignition energy: electrical or thermal

Each corner of the so-called ignition triangle (refer to drawing) represents an indispensable component of such an explosion. Once an exothermic reaction is ignited, the results depending on the energy released can be controlled combustion, flame waves, or explosion.

Today, all protection methods are based on the elimination of one or more factors within the triangle – in order to minimise the potential impacts of the explosion.

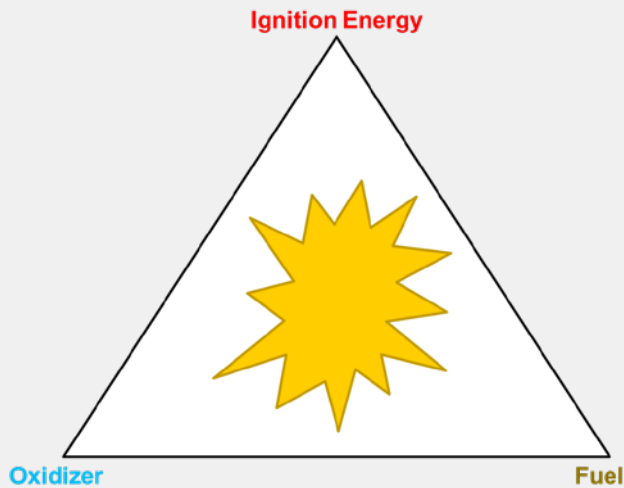

Table 1: Effective ignition sources

Source	Possible Causes
Sparks	Mechanically generated sparks (e.g. by friction, impact or removal processes), electrical sparks
Electric arc	Short-circuit, switching operations
Hot surfaces	Radiators, machining, heating in operation
Open flame, welding arc	Combustion reactions, flying sparks during welding work
Electric arc	Opening/closing of contacts, loose contacts, safety extra-low voltages ( $U < 50V$ ) are not considered as explosion protection measures. Even at low voltages, sufficient energy can still be generated to ignite an explosive atmosphere.
Static electricity	Discharge of charged, insulated conductive parts like e.g. many plastics
Electrical compensation currents, cathodic corrosion protection	Return currents from generators, ground/earth fault in the event of faults, induction
Electromagnetic waves in the range $3 \times 10^{11} \dots 3 \times 10^{15}$ Hz	Laser beam for distance measurement, especially during focusing
High frequency $10^4 \dots 3 \times 10^{12}$ Hz	Radio signals, industrial high frequency generators for heating, drying or cutting
Lightning strike	Atmospheric weather disturbances
Ionising radiation	X-ray apparatus, radioactive material, absorption of energy leads to heating
Ultra sound	Absorption of energy in solids/liquids leads to heating
Adiabatic compression and shock waves	Sudden opening of valves
Exothermic reactions	Chemical reaction leading to heating

# Overview on international standards

Table 2: International standards for electrical equipment in explosive gas atmospheres

Ignition protection category	US standard		Principle	European standard (EN)	IEC Norm	FM (USA)	UL (USA, Div.)	UL (USA, Zone)	CSA (Canada)
General provisions			Ignition protection type	EN 60079-0	IEC 60079-0	FM 3600 (ISA 12.00.01)			CSA E60079-0
Intrinsic safety	Ex i AEx i (IS)	NEC505	Energy limitation	EN 60079-11	IEC 60079-11	FM 3610	UL 913	UL 60079-11	CSA E60079-11
Increased safety	Ex e AEx e	NEC505	Constructional measures (no arcs, sparks or hot surfaces)	EN 60079-7	IEC 60079-7	FM 3600 (ISA 12.16.01)	UL2279 Pt.7	UL 60079-7	CSA E60079-7
Protection by enclosure	tD	NEC505	Exclusion of explosive atmosphere			FM 3615 C22.2 No. 30	e.g.hood/housing: UL 1203		
Flameproof enclosure	Ex d AEx d	NEC505	Constructional measures (enclosing flammable parts of equipment)	EN 60079-1	IEC 60079-1	FM 3600 (ISA 12.22.01)	UL2279 Pt.1	UL 60079-1	CSA E60079-1
Cast enclosure	Ex m AEx m	NEC505	Exclusion of potentially explosive atmosphere	EN 60 079-18	IEC 60079-18	FM 3600 (ISA 12.23.01)	UL2279 Pt.18	UL 60079-18	CSA E60079-18
Oil immersion	Ex o AEx o	NEC505	Exclusion of potentially explosive atmosphere	EN 60079-6	IEC 60079-6	FM 3600 (ISA 12.16.01)	UL2279 Pt.6	UL 60079-6	CSA E60079-6
Powder filling	Ex q AEx q	NEC505	Exclusion of potentially explosive atmosphere	EN 60079-5	IEC 60079-5	FM 3622 FM 3600 (ISA 12.25.01)	UL2279 Pt.5	UL 60079-5	CSA E60079-5
Pressurised	Ex p AExp Typ X, Y, Z	NEC505 NEC500	Exclusion of potentially explosive atmosphere	EN 60079-2	IEC 60079-2				
Ignition protection type "n"	Ex n AEx n	NEC505	Improved industrial quality	EN 60079-15	IEC 60079-15	FM 3600 (ISA 12.12.02)	UL2279 Pt.15	UL 60079-15	CSA E60079-15
Intrinsically safe electrical systems „i- Sys“	Ex i		Restriction of electrical energy within equipment and of wiring exposed to explosive atmosphere	EN 60079-25	IEC 60079-25				
Intrinsically safe Fieldbus systems	Ex i		Energy limitation	EN 60079-27	IEC 60079-27				
Optical radiation	Ex op		Limitation or containment of radiation intensity	EN 60079-28	IEC 60079-28				

# Zone classification in Europe

Table 3: Assignment of equipment group and category

Equipment group	Category	Degree of protection	Protection guarantee	Operating conditions
I	M1	Very high safety degree	If one installation protection measure fails, a second protection measure must guarantee the necessary safety. Even if two independent errors occur, a very high safety level remains guaranteed.	For reasons of safety, it must be possible to continue operating a product even if the atmosphere is potentially explosive.
I	M2	High safety degree	Equipment will switch off, if a potentially explosive atmosphere occurs.	In normal operation, the protective measures must still guarantee the required safety even in difficult conditions, or if equipment is treated roughly or ambient influences have changed.
II	1	Very high	Two independent protective measures guarantee safety, if two faults occur independently of one another.	Equipment can still be used in zones 0, 1, 2(G) and 20, 21, 22 (D) and continue to be operated.
II	2	High	Safety is guaranteed under normal operating conditions, even if common faults occur.	Equipment can be used in zones 1, 2(G) and 21, 22 (D) and continues to be operational.
II	3	Normal	Safety is guaranteed under normal operating conditions.	Equipment can still be used in zones 2(G) and 22 (D) and continues to be operational.

## Equipment group and categories

*Equipment group I:* Equipment intended for use in underground parts and surface installations of mines which is exposed to explosion risks from mine gases and/or combustible dusts. The assigned categories M1 and M2 are defined in the directive 94/9/EC.

*Equipment group II:* Equipment for use in all the other areas that might be endangered by an explosive atmosphere. Three subcategories – 1, 2 and 3 – are defined within this group.

## Zone classification

Hazardous areas are classified into zones to facilitate the selection of appropriate electrical equipment as well as the design of suitable electrical installations – in order to minimise explosion risks. In Germany, dusts

were previously divided into Zones 10 and 11. Following an EC directive, the dual classification system was transferred to a three-zone-scheme, differentiating on the basis of more detailed criteria. As an example, the allocation to a particular zone is now depending on the conductivity of the relevant dust. Conductive dust (with specific electrical resistance  $R > 103 \Omega m$ ) in Zone 22 is allocated to equipment category 2D. In such environments, only apparatus certified for the relevant category (2D) must be used. Devices for non-conductive dusts ( $R > 103 \Omega m$ ) are allocated to category 3D. For these devices, a Manufacturer's Declaration of Conformity is sufficient. In both zones, 0 and 1, only electrical equipment with a Certificate of Conformity complies with the standard –or an EC-Type Examina-

tion Certificate must be present. In addition, equipment for Zone 0 must be explicitly approved for this kind of application. In Zone 2, electrical apparatuses that may concern the basic health and safety requirements of the 94/9/EC Directive are only permitted if the manufacturer declares their compliance with the requirements of the ATEX Directive. Obviously, the equipment certified for use in Zones 0 and 1 can also be used in Zone 2.

Table 4 (refer to provides an overview on the zones of explosive gas atmospheres and the allocation of equipment for the relevant zones. The correlation between category and zones (according to the operator directive 1999/92/EC) is also shown.

**Table 4: Definitions of Zones (acc. to EN 60079-10-1)**

Substance	Zone	Equipment	Illustration
Gases Vapors	Zone 0  Areas where dangerous concentrations of flammable gases/vapors are continuously or long-term present	1G	
	Zone 1  Areas where dangerous concentrations of flammable gases/vapors are occasionally present	2G, 1G	
	Zone 2  Areas where dangerous concentrations of flammable gases/vapors are rarely and – in case only – briefly present	3G, 2G, 1G	
Dust	Zone 20  Areas where dangerous concentrations of flammable dusts occur continuously or for a long term	1D	
	Zone 21  Areas where dangerous concentrations of flammable dusts occasionally occur	2D, 1D	
	Zone 22  Areas where dangerous concentrations of flammable dusts rarely occur and, in case, only briefly	3D, 2D, 1D	

**Type of protection**

The type of protection describes various safety concepts for different applications to prevent the ignition of a potential explosive atmosphere according to European IEC EN 60079 standards. The standards of this series can be applied to equipment individually or in combination. The above spreadsheet shows the allocation of protection types to zones. Protection methods are adapted to the normative standards concerning surface temperature, clearance and creepage distances, to the identification of electrical operating equipment, the assignment of the electrical operating equipment, to the area of application and the degree of protection. For all areas with requirements going beyond basics, the respective protection methods are defined. The IEC EN 60079-0 describes general requirements for the design of electrical equipment used in explosive atmospheres. These requirements are supplemented by individual standards concerning the

types of protection such as IEC EN 60079-6 ff.

**Temperature classes**

With regard to ignition protection, the surface temperature-classes of the equipment groups I and II are different (refer to Figure 1: Temperature classes [°C] of equipment group II). Temperature limits with dust  
In the case of potential dust-explosive areas, the maximum surface temperature is given as a temperature value [°C]. There is no classification into groups. Generally, the permissible temperatures for each type of dust have to be determined by experiments. The maximum surface temperature is different for a dust cloud and a dust layer. With regard to a dust cloud a safety factor has to be considered. The surface temperature of the apparatus must not exceed 2/3 of the minimum ignition temperature of the dust cloud. Deposited dust ignites earlier than a dust cloud. To provide this, a safety factor of 75 K has to be taken in account. This factor refers to the

minimal ignition temperature of a 5 mm dust layer.

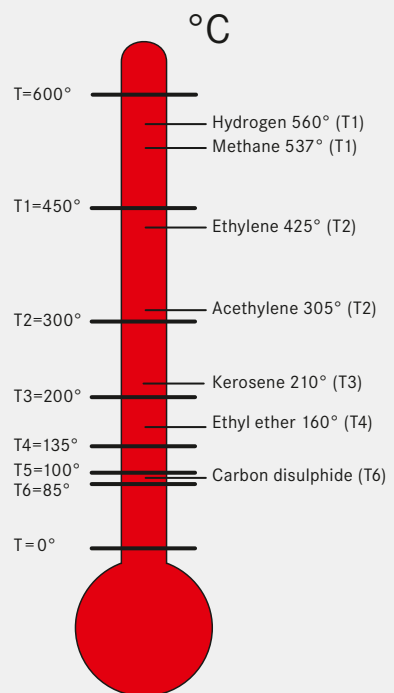

**Figure 1: Temperature classes [°C] of equipment group II, according to European standards and ignition temperatures of relevant substances.**

# Gas explosion groups – European standards

Previously, all chemical gases or vapours used by the industry were classified by assigning them to two different explosion groups (I, II). Meanwhile, the former second explosion group was split in two, thus generating a third group that contains conductive and non-conductive dusts as well as flammable fibres/lint. From the explosion group, the maximum surface temperature can

be derived for electrical equipment that is used in the relevant area or atmosphere. Group I comprises gases creating potentially explosive atmospheres in mines (firedamp). In Group II, different gases, vapors and mists are considered that may create an explosive atmosphere. Group II is again divided into three subgroups (EN 60079-0:2009).

The classification of the subgroups depends on the substance's minimal ignition energy.

**Table 5: Gas explosion group I**

Explosion subgroup	Gases	Ignition energy
I	Firedamp (methane from coal mines)	Maximum permissible temperature depends on deposits of carbon dust in the area

**Table 6: Gas explosion group II**

Explosion subgroup	Gases	Ignition energy
IIA	Propane, acetylene	≈ 300μWs
IIB	Ethylene, ethanol	≈ 150μWs
IIC	Hydrogen, carbon disulphide	≤ 50μWs

**Table 7: Gas explosion group III**

Explosion subgroup	Gases
IIIA	Combustible substances (fibres)
IIIB	Not conductible flammable dust, specific electric resistance > 10 <sup>3</sup> Ω
IIIC	Conductible flammable dust, specific electric resistance ≤ 10 <sup>3</sup> Ω

# Hazardous area classification – North America

## Definition of hazardous area

Explosion-hazardous areas are most frequently found in places where emissions of flammable gas or dust occur. In such areas, gases, vapours, mists and dusts can form explosive atmospheres in combination with air while an equipment is under normal operation or responding to an event of fault, e.g., due to wear and tear of seals or other components. Hazardous atmospheres containing inflammable gases or dusts are designated as risks to machinery and operators.

## Differences to European standards

Concerning standards, we have differences between the European IEC system and the North American electrical codes (CEC, NEC). Inter alia, differences derive from the categorisation of hazardous areas, the

design-in of equipment, and different installation standards.

The categorisation of hazardous areas in North America is derived from the National Electrical Code's (NEC/NFPA) definition of material groups in article 500. There, explosion relevant materials are divided into the following groups:

*Class I – Locations containing flammable gases, flammable liquid-produced vapors, or combustible liquid produced vapors*

*Class II – Locations containing combustible dusts*

*Class III – Locations containing fibres and flyings*

According to the NEC, the differentiation into two divisions – refer to table 8 below – gives the opportunity to determine the probability that a

material is reacting with other materials in the atmosphere.

The North American standards further categorize hazardous areas into groups depending on the properties of the combustible gases or vapors involved (refer to table 9).

**Table 8: Division of materials according to US National Electric Code (NEC)**

	<b>Class I Gases and vapors NEC 500.5</b>	<b>Class II Flammable dust and powder NEC 500.6</b>	<b>Class III Flammable fibres or suspended particles NEC 500.7</b>
Division 1	Areas containing dangerous concentrations of flammable gases, vapors or mist – continuously or occasionally under normal operating conditions	Areas containing dangerous concentrations of flammable dusts – continuously or occasionally under normal operating conditions	Areas containing dangerous concentrations of flammable fibres or suspended particles – continuously or occasionally under normal operating conditions
Division 2	Areas probably not containing dangerous concentrations of flammable gases, vapors or mist – under normal operating conditions	Areas probably not containing dangerous concentrations of flammable dusts – under normal operating conditions	Areas probably not containing dangerous concentrations of flammable fibres or suspended particles – under normal operating conditions



# Hazardous area classification – North America

**Table 9: Subgroups of hazardous area classification**

Class I	Group A	Atmospheres containing acetylene
	Group B	Atmospheres containing hydrogen and flammable process gases with more than 30% of hydrogen in volume, or gases and vapors posing a level of risk comparable to butadiene and ethylene oxide
	Group C	Atmospheres containing ether, ethylene or gases and vapors posing the same level of risk
	Group D	Atmospheres containing acetone, ammonia, benzene, butane, cyclopropane, ethanol, gasoline, hexane methanol, methane, natural gas, naphtha, propane or gases and vapors posing the same level of risk
Class II	Group E	Atmospheres containing combustible metal dusts, including aluminum, magnesium and their commercial alloys, or other combustible dusts which – due to particle size, abrasiveness and conductivity – present a similar threat to the use of electrical equipment
	Group F	Atmospheres containing combustible carbonaceous dusts including carbon black, charcoal, coal, or coke dusts and consisting by more than 8 percent of total entrapped volatiles, or dusts that have been sensitized by other materials, thus causing an explosion hazard
	Group G	Atmospheres containing combustible dusts not included in group E or group F, including fluorine, grain, wood, plastic and other chemicals
Class III		Atmospheres containing easily ignitable fibres and flyings, which will normally not be in suspensions in the air leading to quantities sufficient to produce explosive or ignitable mixtures

The illustration below (Figures 2) shows the different categorizations of classes and divisions of NEC 500 using the example of a gas station.

Since 1996, an additional section has been added to the NEC 500 standard. The new section NEC 505 is based on the IEC model, dividing the

inflammable category with regard to gases and dusts into three zones (0, 1 and 2, refer to Figure 3, next page).

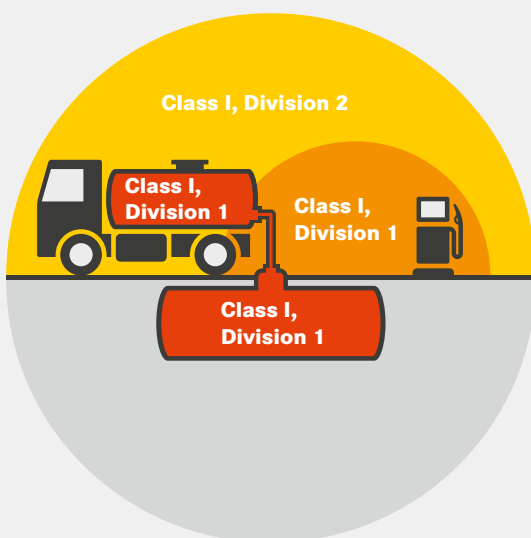

**Figure 2: Classes and divisions using the example of a gas station acc. to NEC 505**

# Hazardous area classification – Europe

The European standard IEC/EN describes the probability of inflammable gases and dusts in three different zones.

Figure 3 describes the different gas zones by the example of a gas station.

Figure 4, refer to illustration below, explains the dust zone classification on the example of a bulk container.

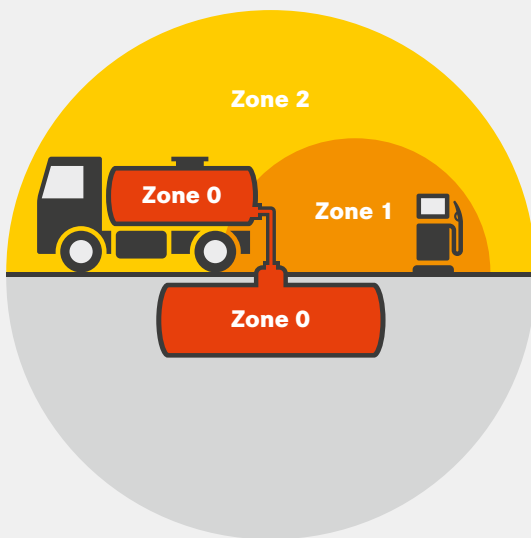

Zoneneinteilung des explosionsgefährdeten Bereichs bei Gasen, laut IEC/EN 60 079

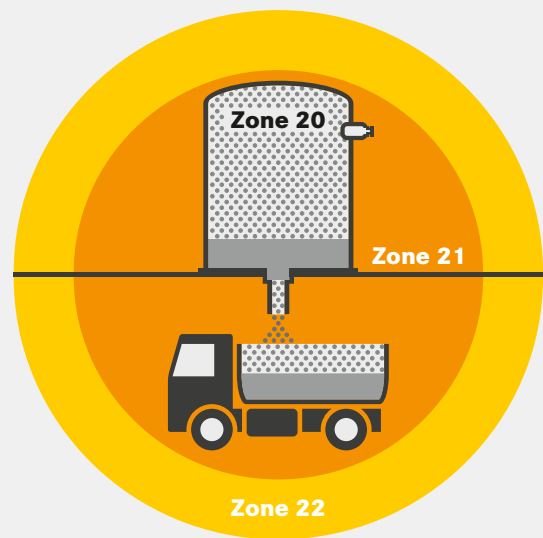

Zoneneinteilung des explosionsgefährdeten Bereichs bei brennbaren Stäuben, laut IEC/EN 60 079

Table 10: Hazardous area zones for mixtures of air with flammable substances (acc. to IEC/EN 60 079)

<b>Zone 0</b>	Areas, where explosive atmospheres consisting of mixtures of air with flammable substances in the form of gas, vapor or mist are present continuously, for long periods of time or frequently
<b>Zone 1</b>	Areas, where explosive atmospheres consisting of mixtures of air with flammable substances in the form of gas, vapor or mist under normal operation conditions are likely to occur occasionally
<b>Zone 2</b>	Areas, where explosive atmospheres consisting of mixtures of air with flammable substances in the form of gas, vapor or mist under normal operation conditions are not likely to occur occasionally

Table 11: Hazardous area zones for combustible dusts (acc. to IEC/EN 60 079)

<b>Zone 20</b>	Areas, where ignitable atmospheres in the form of clouds of combustible dusts in the air are present continuously, for long periods of time or frequently
<b>Zone 21</b>	Areas, where ignitable atmospheres in the form of clouds of combustible dust in the air under normal operational conditions are likely to occur occasionally
<b>Zone 22</b>	Areas, where ignitable atmospheres in the form of clouds of combustible dust in air are not likely to occur under normal operation conditions. If they occur anyway, they will persist for a short period of time only

# Maximum surface temperatures for equipment

The European standard IEC/EN 60079-0 offers a classification for equipment used in explosion hazard areas to three different groups (refer to table 12).

## Categorization of surface temperatures for equipment

Regarding the surface temperature of equipment, the European standard offers six different classes. The categories are defined by the maximum surface temperature for the equipment to remain functional. Figure 5 forms the categories by temperature. The temperature classes are defined

**Table 12: Equipment classification to zones acc. to IEC/EN 60 079-0**

<b>Group I</b>	Equipment used in mining where methane and coal dusts occur in the atmosphere
<b>Group II</b>	Equipment used in industrial environment where explosive gases occur in the atmosphere
<b>Group III</b>	Equipment used in industrial environment where explosive dusts occur in the atmosphere

in relation to a standard environment of 40°C. If an equipment needs a different ambient temperature to be functional, this must be visibly documented on the equipment.

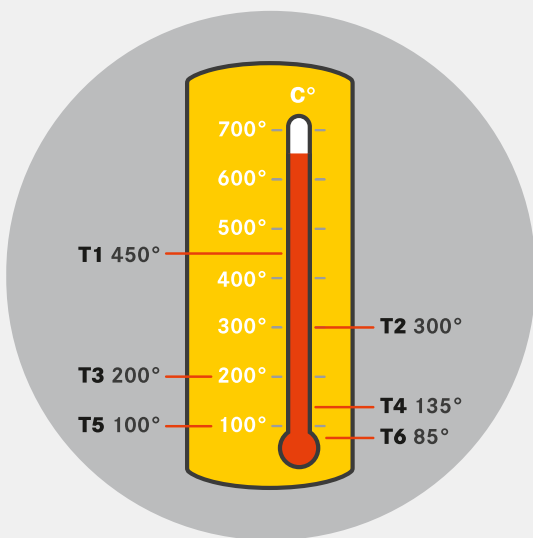

**Figure 5: European classification of maximum surface temperatures for equipment in explosion hazard zones**

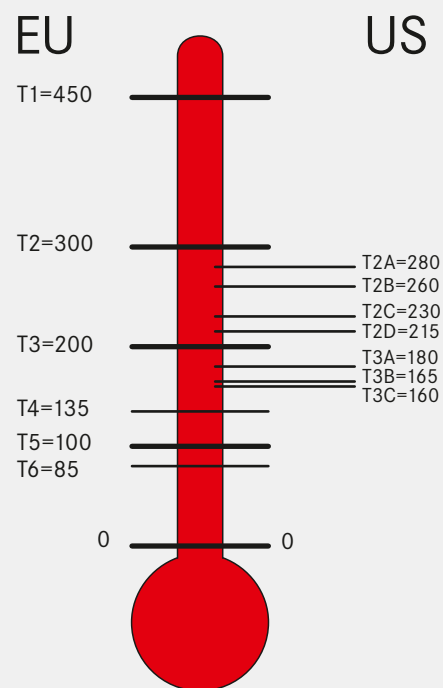

**Figure 6: Equipment groups and maximum surface temperatures acc. to European and North American standards**

# Ignition protection types

Depending on equipment and environment the standards offer different protection principles. Table 13 shows a selection of protection types and principles from an overall of 13

protection methods, defined by the relevant IEC/EN standards. Each type of protection implies various safety concepts for different applications to prevent from the

ignition of a potential explosive atmosphere. The different categories can be applied individually or in combination. The basic standard is IEC/EN 60079-0 ff.

**Table 13: Ignition protection types in potentially explosive gas atmospheres**

Protection types	Basic of protection	GENELEC	IEC	UL	Zone, Class	Protection principle
Ex d 	Flameproof	EN 60079 -1	IEC 60079 -1	UL 60079-1	Class 1, Zone 2	Explosion prevention
Ex e 	Increased safe	EN 60079 -7	IEC 60079-7	UL 60079-7	Class 1, Zone 2	Prevention of sparks
Ex m 	Encapsulation	EN 60079-18	IEC 60079-18	UL 60079-18	Class 1, Zones 0 and 1	Exclusion of explosion atmosphere
Ex q 	Powder filling	EN 60079-5	IEC 60079-5	UL 60079-5	Class 1, Zones	Prevention of sparks
Ex tD 	Protection by enclosure	EN 60079-31	IEC 60079-31	ISA 61241-1	Class 2, Zones 21 and 22	Exclusion of explosion atmosphere
Ex p 	Pressurized	EN 60079-2	IEC 60079-2	UL 60079-2	Class 1, Zone 1	Exclusion of explosion atmosphere
Ex o 	Oil immersion	EN 60079-6	IEC 60079-6	UL 60079-6	Class 1, Zone 1	Exclusion of explosion atmosphere
Ex i 	Intrinsic safe	EN 60079-11	IEC 60079-11	UL 60079-11	Class 1, Zones 0 and 1	Energy limitation

# Connecting Ex and Non-Ex areas

Han® Ex connectors are designed to meet the intrinsic safety requirements for ignition protection in explosion-hazardous areas zoned 1 and 2. In intrinsically safe circuits, a limit is set to energy so that even a spark would not ignite an explosive environment. With the Han® Ex series, HARTING offers a comprehensive and well-matched connection systems consisting of hoods/housings, inserts and cable glands. Hoods and housings are made from an alloy that

can safely be used in a methane-coal atmosphere. In addition, hoods and housings offer protection IP65 (in mated position). Furthermore, the hood's/housing's blue colour indicates that an intrinsically safe circuit is present. The inserts compatible with Han® Ex allow for high-density contact arrangements, meeting the standards of the category *intrinsically safe* even in the tightest of spaces. Han® Ex connectors are designed especially for the named explosion

protection method. The intrinsic safety protection technique is based on the limitation of energy supply, thus ensuring a safe operation of electrical equipment in hazardous areas. The limitations may relate to current, voltage, capacitance and/or inductivity. Finally, a Han® Ex connector is always part of a comprehensive supply system for devices in the field, including current transfers between Ex and Non-ex areas, which is explained by Figure 7.

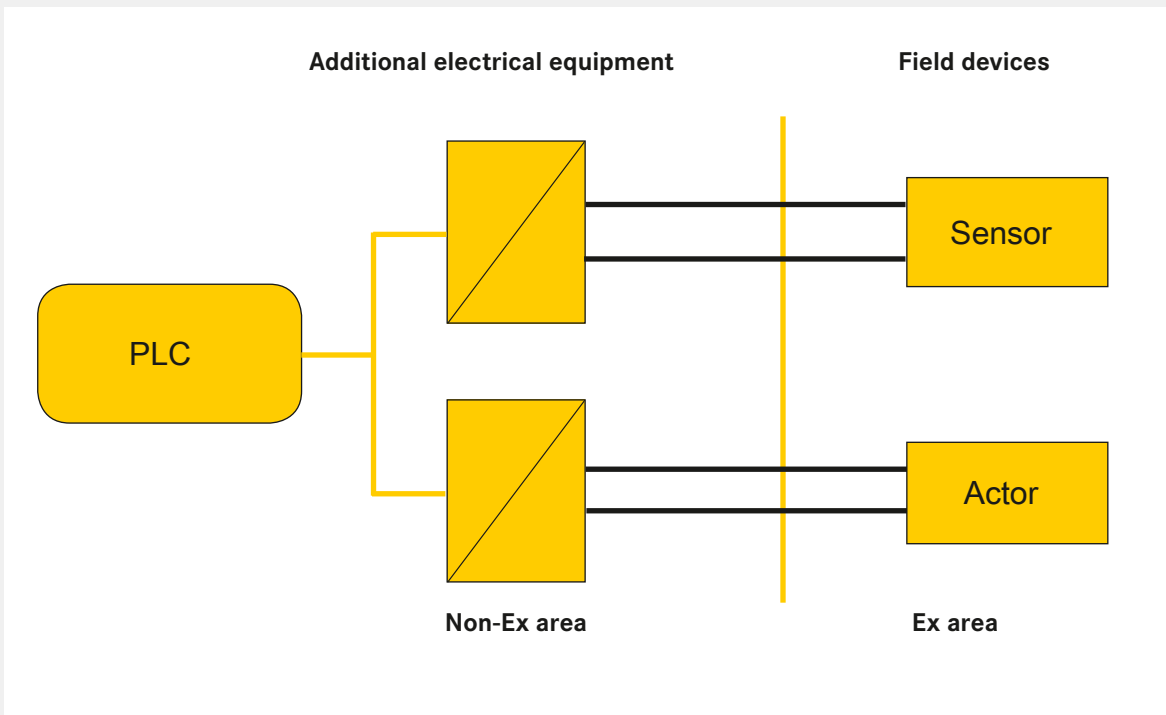

Figure 7: Han® Ex is a comprehensive connector system allowing for the safe transmission of power, signal and data between Non-Ex and Ex areas.



Connector sets for explosion-hazardous environments

## Features

- Connector sets especially for explosion-hazardous applications
- Suitable for zone 1 and zone 2
- Hoods, housings and inserts in one set
- Inserts with compact design and a high number of connections
- Available with innovative Han-Quick Lock® termination technology

**NOTICE** Industrial connectors of the Han® Ex series are designed exclusively for the use in intrinsically safe electrical circuits of categories "ia", "ib" and "ic"!

- ▶ The explosion group is defined by the corresponding intrinsically safe equipment.
- ▶ Temperature class according to DIN EN 60079-11

## Technical characteristics

Specifications	DIN EN 60 079-0 DIN EN 60 079-11
Hoods/housings	
Material	Zinc die cast
Colour	RAL 5015 (blue)
Surface	Powder coated
Locking element	Stainless steel
Lever type	Netal lever
Seal	NBR
Limiting temperatures	-20 °C ... +40 °C
Protection degree acc. to DIN EN 60 529 in locked position	IP65 / IP67 is achieved with seal screw and cable gland
Inserts	
Number of contacts	4, 7, 8, 12
Pollution degree	3
Insulation resistance	≥ 10 <sup>10</sup> Ω
Material	Polycarbonat
Limiting temperatures	-20 °C ... +40 °C
Mechan. working life - mating cycles	≥ 500
Contacts	
Material	Copper alloy
Surface	
- hard-silver plated	3 µm Ag
Contact resistance	≤ 1 mΩ
Crimp termination	0.14 ... 2.5 mm <sup>2</sup> AWG 26 ... 14
Han-Quick Lock® termination	0.5 ... 2.5 mm <sup>2</sup> AWG 20 ... 14
Max. insulation diameter	3.6 mm

Identification	Part number	Size	Drawing	Dimensions in mm
<p>Han® Ex 4A Quick Lock Set</p> <p> Han-Quick Lock®</p>	10 36 004 0003	3 A		<p>Contact arrangement view: termination side</p>
<p>Han® Ex 8D Quick Lock Set</p> <p> Han-Quick Lock®</p>	10 36 008 0007	3 A		<p>Panel cut out: 22 x 22 mm</p>

## Assembly manual

Remove cable jacket and strip the fine stranded wires.

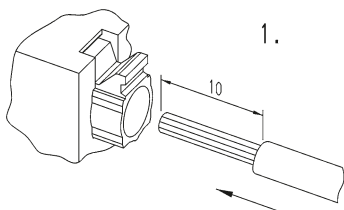

Do not twist the fine stranded wires!

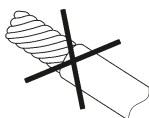

Push the fine stranded wires into the Han-Quick Lock® contact and push the blue slide with a screw driver<sup>1)</sup> until it comes to a stop.

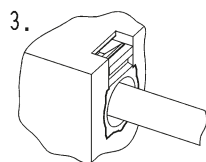
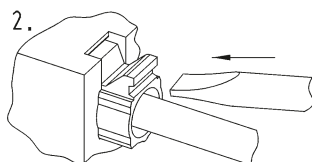





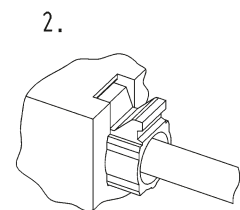
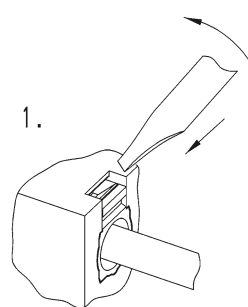

## Removal manual

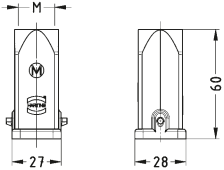
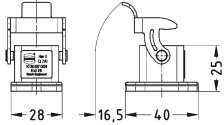
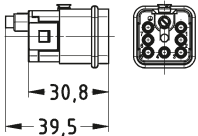
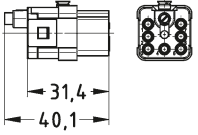
Insert the screw driver<sup>1)</sup> at an angle of 45° into the opening and lever the blue slide out.

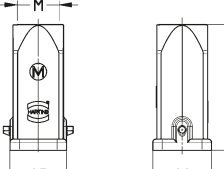
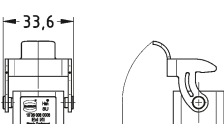
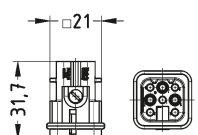
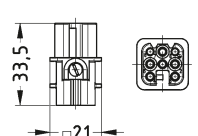

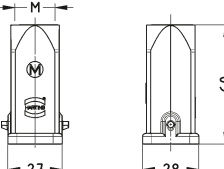
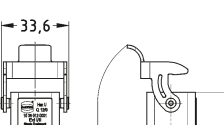
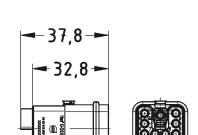
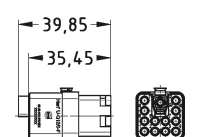
<sup>1)</sup> Screw driver: 0.4 x 2.5 mm

Identification	Part number	Size	Drawing	Dimensions in mm
<b>Han® Ex Q7 Set</b> Order crimp contacts separately! 	10 36 007 0001	3 A	M  F  Panel cut out: 22 x 22 mm	  Contact arrangement view: termination side
<b>Han® Ex 8D Set</b> Order crimp contacts separately! 	10 36 008 0006	3 A	M  F  Panel cut out: 22 x 22 mm	 
<b>Han® Ex Q12 Set</b> Order crimp contacts separately! 	10 36 012 0001	3 A	M  F  Panel cut out: 22 x 22 mm	 

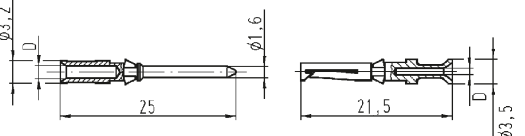
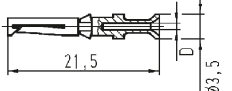
Identification	Wire gauge		Part number		Drawing	Dimensions in mm																											
	mm <sup>2</sup>	Male contact	Female contact																														
<b>Crimp contact</b> silver plated 	0.14-0.37	09 15 000 6104	09 15 000 6204			<table border="1"> <thead> <tr> <th>Wire gauge</th> <th>Ø mm</th> <th>Stripping length</th> </tr> </thead> <tbody> <tr> <td>0.14-0.37 mm<sup>2</sup></td> <td>AWG 26-22</td> <td>0.9</td> <td>8 mm</td> </tr> <tr> <td>0.5 mm<sup>2</sup></td> <td>AWG 20</td> <td>1.1</td> <td>8 mm</td> </tr> <tr> <td>0.75 mm<sup>2</sup></td> <td>AWG 18</td> <td>1.3</td> <td>8 mm</td> </tr> <tr> <td>1.0 mm<sup>2</sup></td> <td>AWG 18</td> <td>1.45</td> <td>8 mm</td> </tr> <tr> <td>1.5 mm<sup>2</sup></td> <td>AWG 16</td> <td>1.75</td> <td>8 mm</td> </tr> <tr> <td>2.5 mm<sup>2</sup></td> <td>AWG 14</td> <td>2.25</td> <td>6 mm</td> </tr> </tbody> </table>	Wire gauge	Ø mm	Stripping length	0.14-0.37 mm <sup>2</sup>	AWG 26-22	0.9	8 mm	0.5 mm <sup>2</sup>	AWG 20	1.1	8 mm	0.75 mm <sup>2</sup>	AWG 18	1.3	8 mm	1.0 mm <sup>2</sup>	AWG 18	1.45	8 mm	1.5 mm <sup>2</sup>	AWG 16	1.75	8 mm	2.5 mm <sup>2</sup>	AWG 14	2.25	6 mm
	Wire gauge	Ø mm	Stripping length																														
	0.14-0.37 mm <sup>2</sup>	AWG 26-22	0.9				8 mm																										
	0.5 mm <sup>2</sup>	AWG 20	1.1				8 mm																										
	0.75 mm <sup>2</sup>	AWG 18	1.3				8 mm																										
	1.0 mm <sup>2</sup>	AWG 18	1.45				8 mm																										
	1.5 mm <sup>2</sup>	AWG 16	1.75				8 mm																										
2.5 mm <sup>2</sup>	AWG 14	2.25	6 mm																														
0.5	09 15 000 6103	09 15 000 6203																															
0.75	09 15 000 6105	09 15 000 6205																															
1.0	09 15 000 6102	09 15 000 6202																															
1.5	09 15 000 6101	09 15 000 6201																															
2.5	09 15 000 6106	09 15 000 6206																															





Connectors for explosion hazardous environments – standard sizes

## Features

- Hoods and housings in the sizes 6 B, 10 B, 16 B, 24 B and 48 B
- Connectors especially for explosion hazardous applications
- Suitable for intrinsically safe circuits
- Inserts on basis of Han® E with 6 to 24 contacts
- Suitable for areas classed 1 und 2

**⚠ WARNING!** Industrial connectors of the Han® Ex series are designed exclusively for the use in intrinsically safe electrical circuits of categories „ia“, „ib“ and „ic“!

- ▶ The explosion group is defined by the corresponding intrinsically safe equipment.
- ▶ Temperature class according to DIN EN 60079-11





## General description





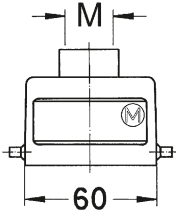
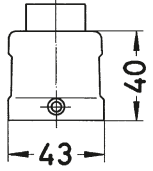

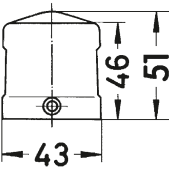
The connectors are designed to meet the intrinsic safety requirements for ignition protection class in explosion hazardous areas classed as 1 and 2. In intrinsically safe circuits, energy is limited in such a manner that even a potential spark cannot ignite an explosive environment.

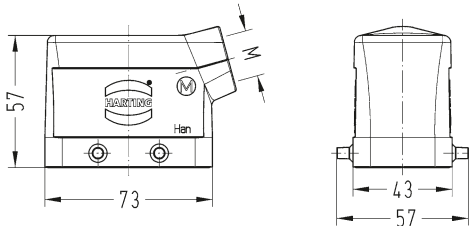
The Han® Ex product portfolio offers complete connector systems consisting of housings and inserts, including housings made from an alloy that can be used in pulverised methane-coal dust atmospheres. They also offer ignition protection class 65 in the mated condition. The housing's blue colour indicates that an intrinsically safe circuit is present. The contact inserts provide a high number of pins and meet the standards of the ignition protection class even in the tightest of spaces.

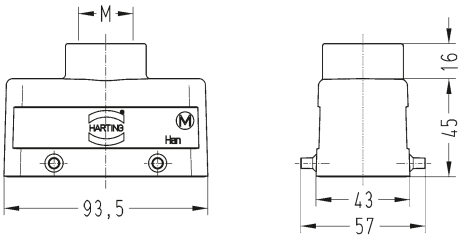

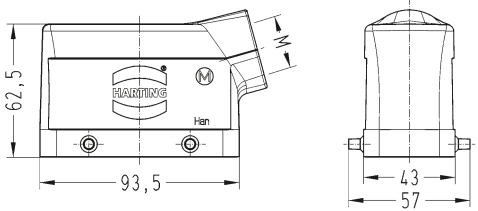

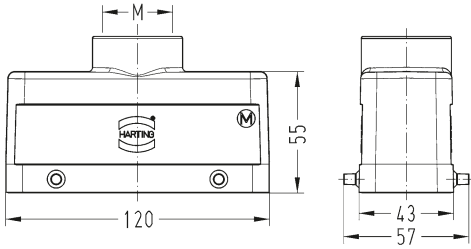

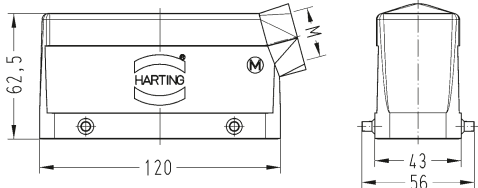
## Technical characteristics



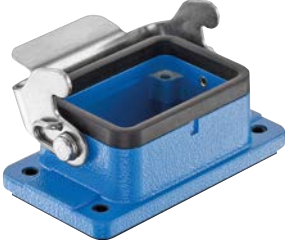
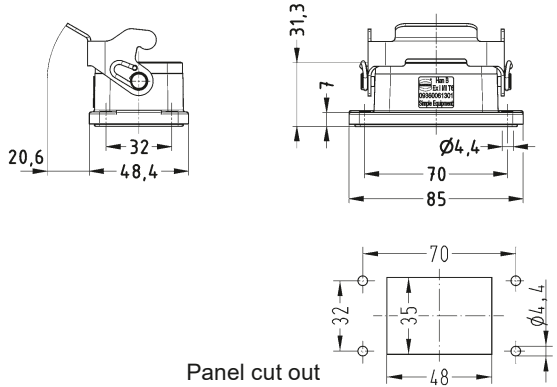

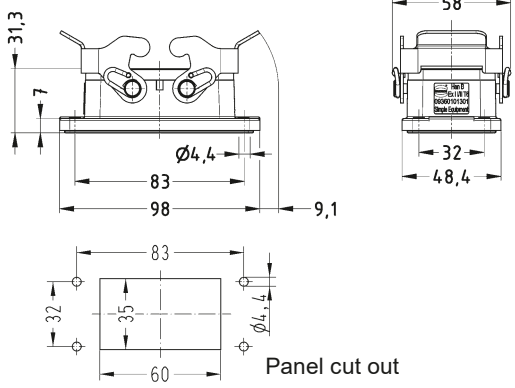
<b>Specifications</b>	DIN EN 60 079-0, -11, -14 DIN EN 60 664-1 DIN EN 61 984
<b>Hoods/ housings</b>	
Material	zinc die cast
Colour	RAL 5015 (blue)
Surface	powder coated
Locking element	stainless steel
Lever type	metal lever
Seal	NBR
Ambient temperature acc. to DIN EN 60 079-11	-20 °C ... +40 °C
Limit temperature for connectors	-40 °C ... +125 °C
Maximum surface temperature acc. to DIN EN 60 079-11	T6 = 85 °C
Protection degree acc. to DIN EN 60 529 in locked position	IP65 is achieved with cable gland
<b>Inserts</b>	
Number of contacts	6, 10, 16, 24
Rated current	16 A
Rated voltage	90 V
Insulation resistance	≥ 10 <sup>10</sup> Ω
Material	polycarbonate
Limiting temperatures acc. to DIN EN 60 079-11	-20 °C ... +40 °C
Mechan. working life - mating cycles	≥ 500
<b>Contacts</b>	
Material	copper alloy
Surface - hard-silver plated	3 µm Ag
Contact resistance	≤ 1 mΩ
Crimp termination	0.14 ... 2.5 mm <sup>2</sup> AWG 26 ... 14
Screw connection	0.75 ... 2.5 mm <sup>2</sup>
Tightening torque	0.5 Nm
Max. insulation diameter	3.6 mm

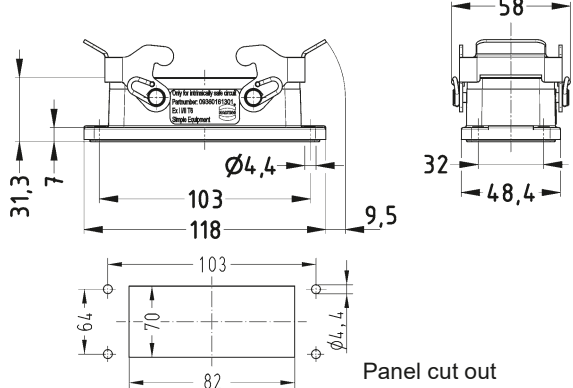
Identification	Part number	Cable entry	Drawing	Dimensions in mm
Hood 6 B top entry 	19 36 006 1440 19 36 006 1441	M20 M25		
Hood 6 B side entry 	19 36 006 1540 19 36 006 1541	M20 M25		
Hood 10 B top entry 	19 36 010 1420 19 36 010 1421	M20 M25		
Hood 10 B side entry 	19 36 010 1520 19 36 010 1521	M20 M25		

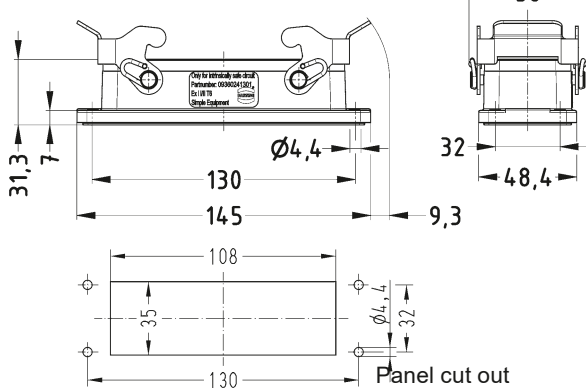
<p>Hood 16 B top entry</p> 	<p>19 36 016 1421 19 36 016 1422</p>	<p>M25 M32</p>	
<p>Hood 16 B side entry</p> 	<p>19 36 016 1521 19 36 016 1522</p>	<p>M25 M32</p>	
<p>Hood 24 B top entry</p> 	<p>19 36 024 1421 19 36 024 1422</p>	<p>M25 M32</p>	
<p>Hood 24 B side entry</p> 	<p>19 36 024 1521 19 36 024 1522</p>	<p>M25 M32</p>	

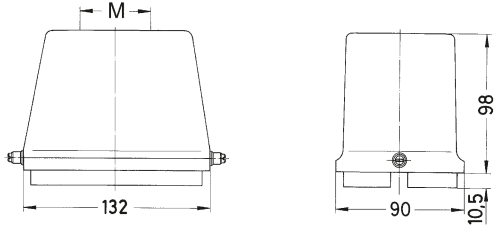
# Hoods and Housings – Sizes 6 B, 10 B, 16 B, 24 B, 48 B

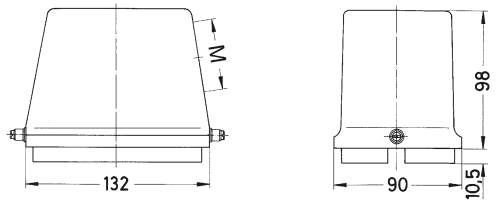
Identification	Part number	Drawing	Dimensions in mm
<p>Housing, bulkhead mounted 6 B</p> 	<p>09 36 006 1301</p>	 <p>Panel cut out</p>	<p>Dimensions in mm</p>
<p>Housing, bulkhead mounted 10 B</p> 	<p>09 36 010 1301</p>	 <p>Panel cut out</p>	<p>Dimensions in mm</p>
<p>Housing, bulkhead mounted 16 B</p> 	<p>09 36 016 1301</p>	 <p>Panel cut out</p>	<p>Dimensions in mm</p>
<p>Housing, bulkhead mounted 24 B</p> 	<p>09 36 024 1301</p>	 <p>Panel cut out</p>	<p>Dimensions in mm</p>

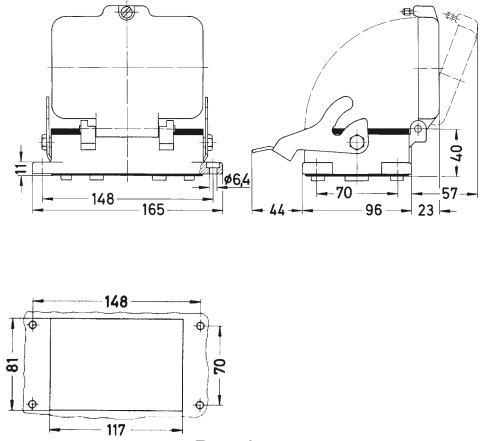
Identification	Part number	Cable entry	Drawing	Dimensions in mm
<p>Hood 48 B top entry</p> 	<p>19 36 048 0447 19 36 048 0448</p>	<p>M32 M40</p>		
<p>Hood 48 B side entry</p> 	<p>19 36 048 0547 19 36 048 0548</p>	<p>M32 M40</p>		
<p>Hood 48 B with cover</p> 	<p>09 36 048 0301</p>		 <p>Panel cut out</p>	

**Armenia:**

Refer to Russia

**Australia and Oceania**

HARTING Pty. Ltd.  
Suite 11 / 2 Enterprise Drive  
Bundoora 3083, University Hill  
Melbourne, Victoria  
Phone 1800 201 081  
+61 3 9466 7088  
au@HARTING.com

**Australia and Oceania:**

Refer to Australia

**Austria**

HARTING Ges.m.b.H.  
Deutschstraße 19  
1230 Wien  
Phone +43 161 621 21  
at@HARTING.com

**Azerbaijan:**

Refer to Turkey

**Baltic States:**

Refer to Finland

**Belarus:**

Refer to Russia

**Belgium**

HARTING N.V.  
Z.3 Doornveld 23  
1731 Zellik  
Phone +32 2 466 0190  
be@HARTING.com

**Bosnia Herzegovina:**

Refer to Austria

**Brazil**

HARTING Ltda.  
Alameda Caiapós, 643  
06460-110- Barueri - São Paulo  
Phone +55 11 5035 0073  
br@HARTING.com

**Canada**

HARTING Canada Inc.  
475 Dumont Avenue, Suite 300  
Dorval, Quebec, H9S 5W2  
Phone +1 855 659-6653  
info.ca@HARTING.com

**Central America and the****Caribbean:**

Refer to USA

**Central Asia:**

Refer to Russia

**China**

HARTING (Zhuhai) Sales Ltd.  
Room 3501, Grand Gateway I  
No. 1 Hong Qiao Road  
Xu Hui District  
Shanghai 200030  
Phone +86 21 3418 9758  
cn@HARTING.com

**Croatia:**

Refer to Austria

**Czech Republic**

HARTING s.r.o.  
Mlýnská 2  
160 00 Praha 6  
Phone +420 220 380 495  
cz@HARTING.com

**Denmark**

HARTING ApS  
Resilience House  
Lysholt Allé 8  
7100 Vejle  
Phone +45 70 25 00 32  
dk@HARTING.com

**Finland**

HARTING Oy  
Teknobulevardi 3-5  
01530 Vantaa  
Phone +358 207 291 510  
fi@HARTING.com

**France**

HARTING France EURL  
ZAC Paris Nord 2  
181 avenue des Nations  
95934 ROISSY CDG  
Phone +33 1 4938 3400  
fr@HARTING.com

**Germany**

HARTING Deutschland  
GmbH & Co. KG  
Simeonscarré 1  
D-32427 Minden  
Phone +49 571 8896 0  
de@HARTING.com

**Georgia:**

Refer to Russia

**Great Britain**

HARTING Limited  
Caswell Road  
Brackmills Industrial Estate  
NN4 7PW GB - Northampton  
Phone +44 1604 82 75 00  
salesuk@HARTING.com

**Greece:**

Refer to Italy

**Hong Kong**

HARTING (HK) Limited  
Regional Office Asia Pacific  
3512, Metroplaza Tower 1  
223 Hing Fong Road  
Kwai Fong, N. T.  
Phone +852 2423 7338  
ap@HARTING.com

**Hungary**

HARTING Magyarország Kft.  
Fehérvári út 89-95  
1119 Budapest  
Phone +36 1 205 34 64  
hu@HARTING.com

**India**

HARTING (India) Private Limited  
7th Floor (West Wing)  
Central Square II  
Unit No.B 19 part, B 20 & 21  
TVK Industrial Estate  
Guindy, Chennai 600032  
Phone +91-44-43560415  
in@HARTING.com

**Ireland:**

Refer to Great Britain

**Israel:**

Refer to Turkey

**Italy**

HARTING S.R.L.  
Via dell' Industria 7  
20090 Vimodrone (MI)  
Phone +39 02 250801  
it@HARTING.com

**Japan**

HARTING K.-K.  
Yusen Shin-Yokohama  
1 Chome Bldg., 2F 1-7-9,  
Shin-Yokohama, Kohoku-ku  
Yokohama 222-0033  
Phone +81 45 476 3456  
jp@HARTING.com

**Korean Republic**

HARTING Korea Co. Ltd.  
B-B108, Worim Lions Valley 5th,  
302 Galmachi-ro, Jungwon-gu,  
Seongnam-si, Gyeonggi-do,  
13201 Republic of Korea  
Phone +82 31 750 0380  
kr@HARTING.com

**Kosovo:**

Refer to Austria

**Macedonia:**

Refer to Austria

**Malta:**

Refer to Italy

**Mexico**

HARTING Mexico S.A. de C.V.  
IOS Torre Virreyes  
Pedregal No. 24,  
Co. Molino Del Rey  
Suites 357 A, B, C  
Del Miguel Hidalgo  
Mexico D.F. 11600  
Phone +1 800 123 0415  
HARTING.mexico@HARTING.com

**Middle East:**

Refer to United Arab Emirates

**Montenegro:**

Refer to Austria

**Netherlands**

HARTING B.V.  
Larenweg 44  
5234 's-Hertogenbosch  
Phone +31 736 410 404  
nl@HARTING.com

**Norway**

HARTING A/S  
Østensjøveien 36  
0667 Oslo  
Phone +47 22 700 555  
no@HARTING.com

**Pakistan:**

Refer to United Arab Emirates

**Poland**

HARTING Polska Sp. z o.o.  
ul. Duńska 11  
54-427 Wrocław  
Phone +48 71 352 81 71  
pl@HARTING.com

**Romania**

HARTING Romania SCS  
Str. Europa Unita nr 21  
550018 Sibiu  
Phone +40 369 102 610  
ro@HARTING.com

## Russia

LLC HARTING  
Sverdlovskaya nab., 44,  
lit. Yu, office 612  
195027, St. Petersburg  
Phone +7 812 327 6477  
ru@HARTING.com

## Serbia:

Refer to Austria

## Singapore

HARTING Singapore Pte. Ltd.  
25 International Business Park  
#04-108 German Centre  
SGP-Singapore 609916  
Phone +65 6225 5285  
sg@HARTING.com

## Slovakia

HARTING s.r.o.  
Slovakia branch  
Štefániková Trieda 71, (areál  
pivovaru)  
949 01 Nitra  
Phone +421 37 655 9089  
sk@HARTING.com

## Slowenia:

Refer to Austria

## South Africa

HARTING South Africa  
Proprietary Ltd.  
Ground Floor, Twickenham  
Building  
The Campus  
Cnr Main & Sloane Street  
Bryanston, Johannesburg 2021  
South Africa  
Phone +27 (0) 11 575 0017  
za@HARTING.com

## South America:

Refer to Brazil

## South Asia:

Refer to Singapore

## South Pacific:

Refer to Australia

## Spain

HARTING Iberia S.A.U.  
C/Viriato, 47 8<sup>a</sup> Planta  
Edificio Numancia, 1  
08014 Barcelona  
Phone +34 933 638 484  
es@HARTING.com

## Sub-Sahara countries:

Refer to South Africa

## Sweden

HARTING AB  
Gustavslundsvägen 141B  
167 51 Bromma  
Phone +46 8 445 7171  
se@HARTING.com

## Switzerland

HARTING AG  
Volketswil branch  
Hofwiesenstrasse 4 A  
8604 Volketswil  
Phone +41 44 908 20 60  
ch@HARTING.com

## Taiwan

HARTING Taiwan Ltd.  
Room 1, 5/F, 495 GuangFu South  
Road  
RC-110 Taipei  
Phone +886 227 586 177  
tw@HARTING.com

## Turkey

HARTING Türkiye Elektronik  
Ticaret  
Limited Sirketi  
Bayar Cad. Şehit İknur Keleş  
Sok.  
Dural Plaza No:3 K.11  
34742 Kozyatagi – Istanbul  
Phone +90 216 688 81 00  
tr@HARTING.com

## Ukraine:

Refer to Poland

## United Arab Emirates

HARTING Middle East FZ-LLC  
Knowledge Village  
Block 2A – Office F72  
P.O. Box: 454372  
Dubai  
Phone +971 4 453 9737  
uae@HARTING.com

## HARTING Inc. of North America

1370 Bowes Road  
USA-Elgin, Illinois 60123  
Phone +1 847 741 1500  
us@HARTING.com

# Distributors – worldwide / General contact

**ARROW:** [www.arrow.com](http://www.arrow.com)

**Digi-Key Corporation:**  
[www.digikey.com](http://www.digikey.com)

**Farnell:** [www.farnell.com](http://www.farnell.com)

**FUTURE Electronics:**  
[www.futureelectronics.com](http://www.futureelectronics.com)

**HEILIND Electronics:**  
[www.heilind.com](http://www.heilind.com)

**Mouser Electronics:**  
[www.mouser.com](http://www.mouser.com)

**RS Components:**  
[www.rs-components.com](http://www.rs-components.com)

**HARTING Electric**  
GmbH & Co. KG  
P.O. Box 1473  
D-32328 Espelkamp  
Germany  
Phone +49 5772/47-97100  
[electric@HARTING.com](mailto:electric@HARTING.com)  
[www.HARTING.com](http://www.HARTING.com)

**HARTING Electronics GmbH**  
P.O. Box 1433  
32328 Espelkamp  
Germany  
Phone +49 5772/47-97200  
[electronics@HARTING.com](mailto:electronics@HARTING.com)  
[www.HARTING.com](http://www.HARTING.com)



Pushing Performance

**HARTING.com** –  
the gateway to your  
country website.

---

**HARTING Technology Group**  
info@HARTING.com  
www.HARTING.com  
www.product-news.HARTING.com